

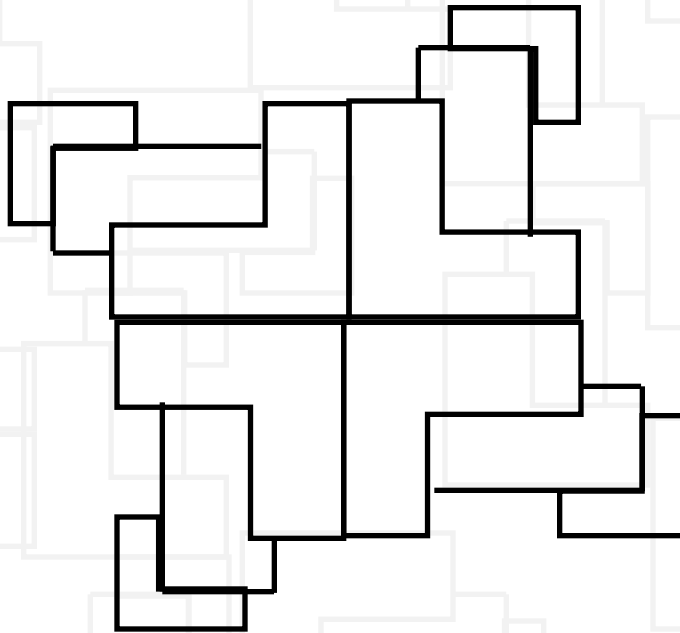

PANDORA
REVISITED

'elle'
the key



known as 'eLLe' , it is said that this is the only configuration that can open the mysterious door in Antarctica. However, it must be made of ice.

Dr Pandora has been researching on achieving this configuration and these keywords seem to bring her closer to the key.

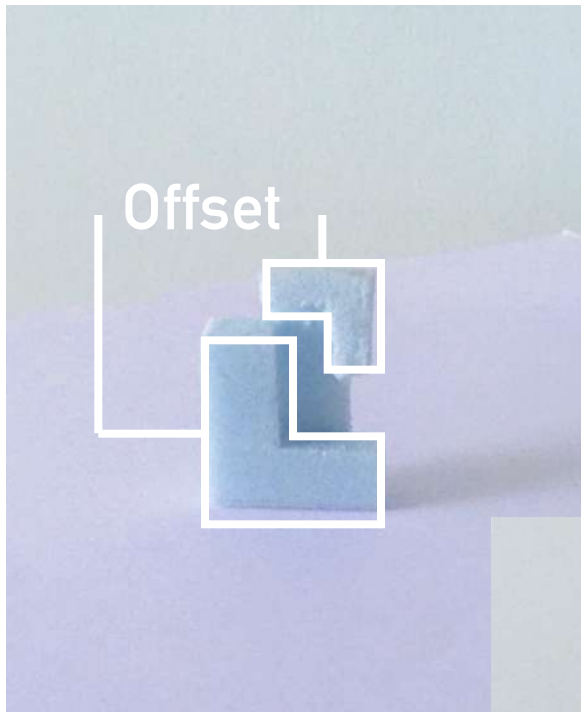
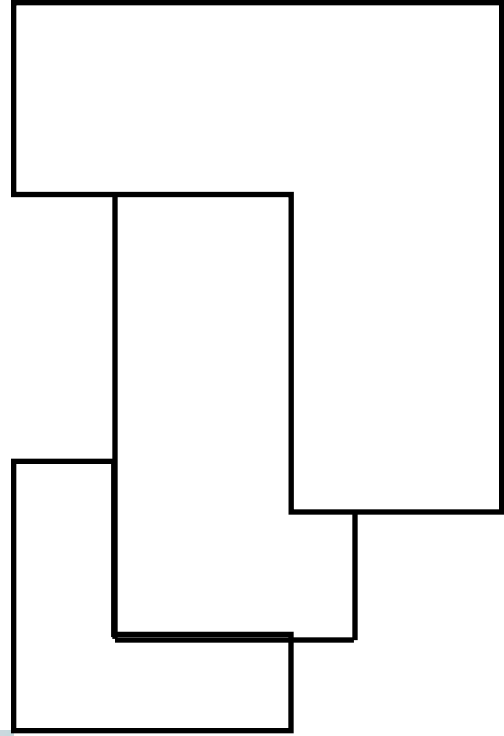

Keywords:

Shift
Offset
Shift

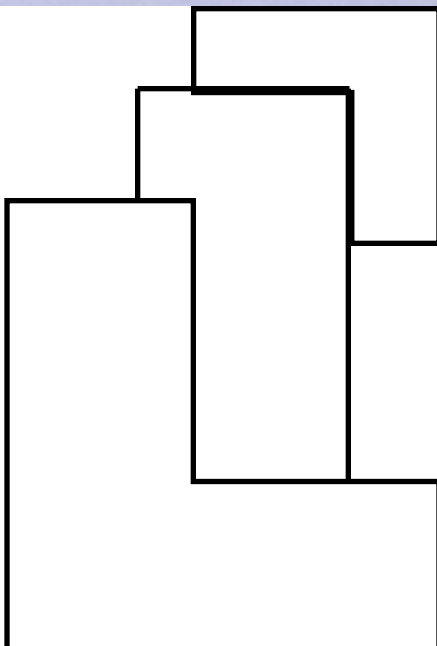
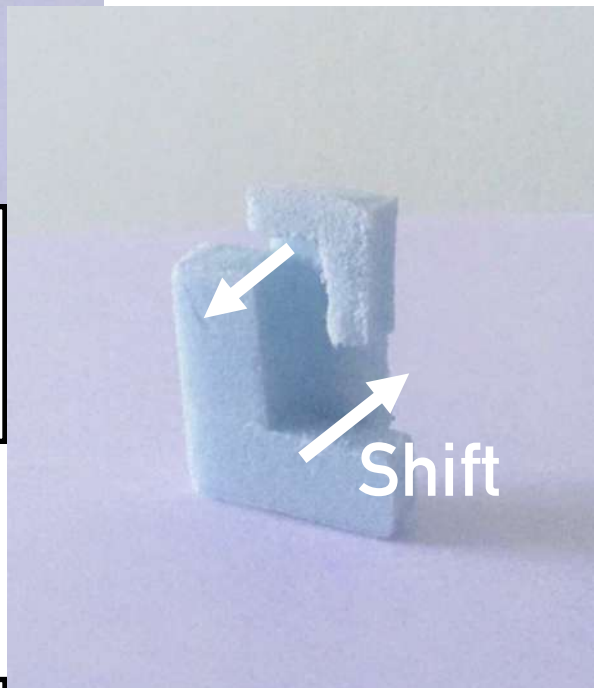

With the findings she got, she worked towards the calculations to create eLLe.

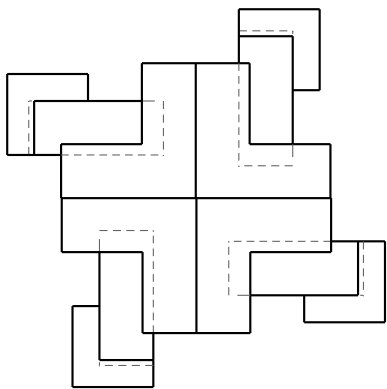
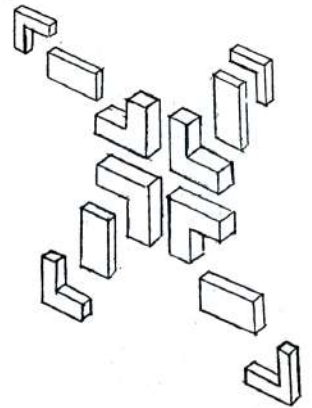
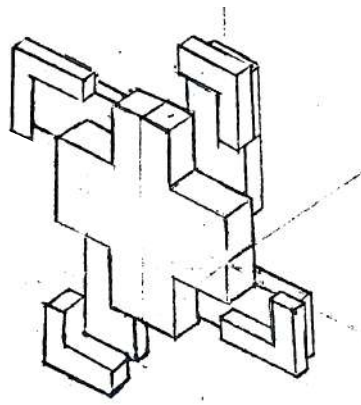

Front view

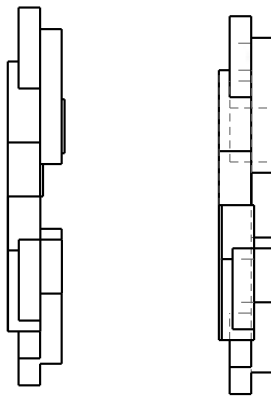

Side views



Top and Bottom

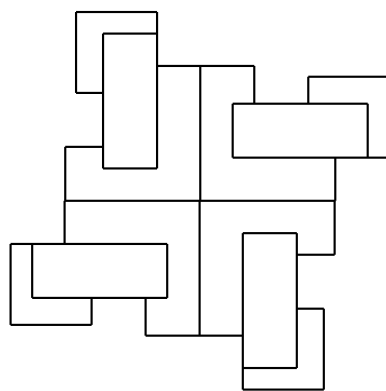

Back view

After numerous attempts, Dr Pandora finally seems to have got the configuration right and has created the ice key.



**Will it be able to
open the door?**

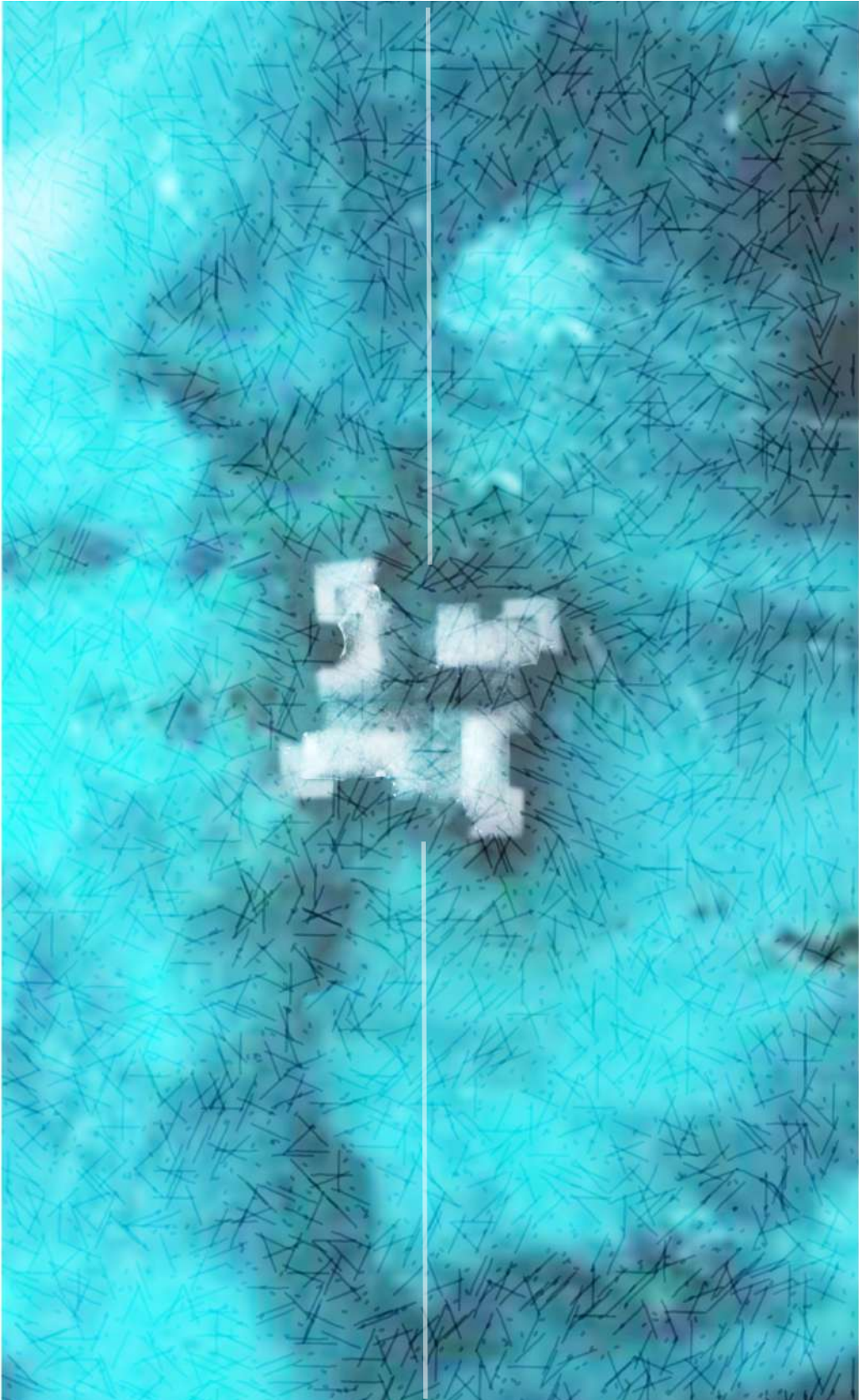

END.