

BEND \ NOTCH \ ARRAY

Bend: shape or force something into a curve or angle
Notch: an indentation or incision on an edge or surface
Array: display or arrange things in a curved manner

individual ice modules

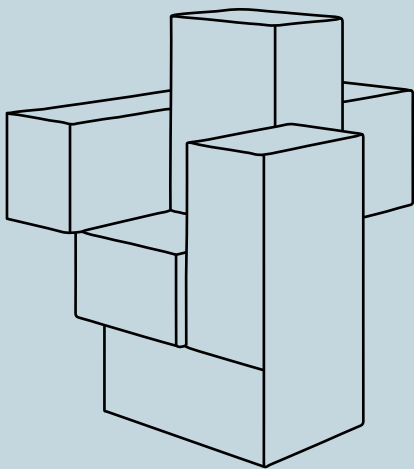

angular edges - bend
cuddling one another - notch
final arrangement - array

PLANS

Top View

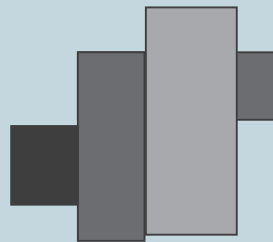

Bottom View

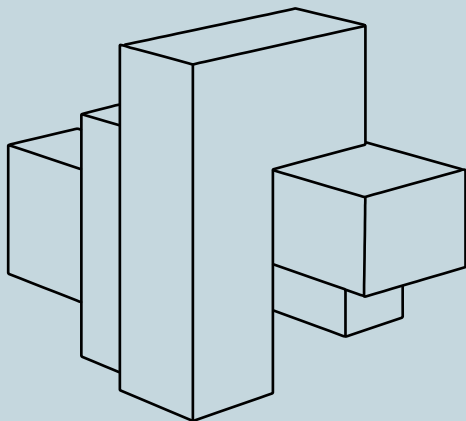

ELEVATION

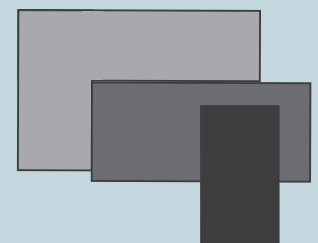
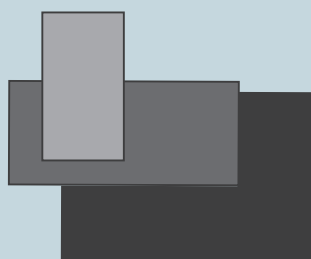
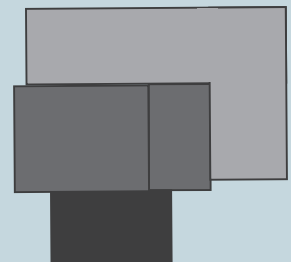
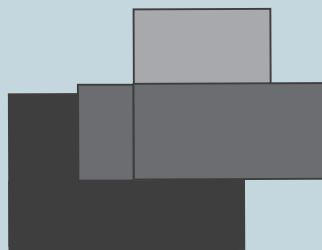

final ice tray arrangement

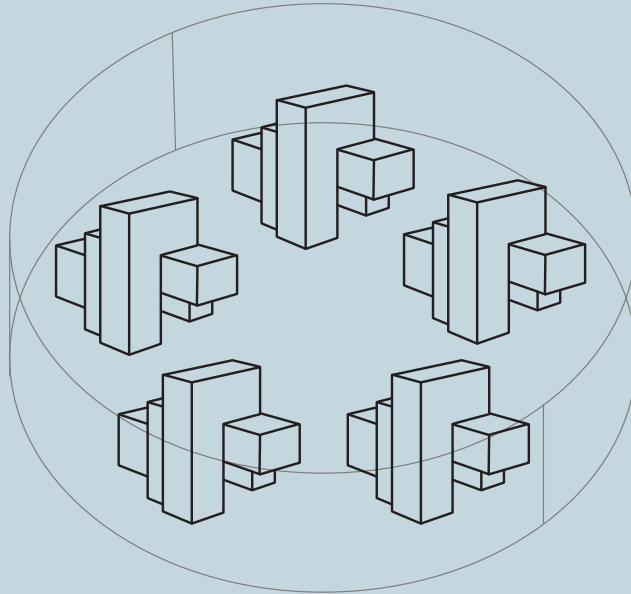

section

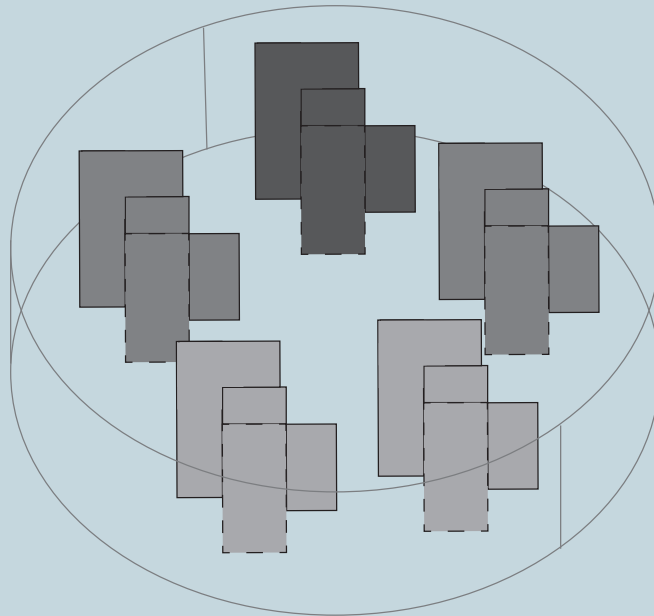

plan

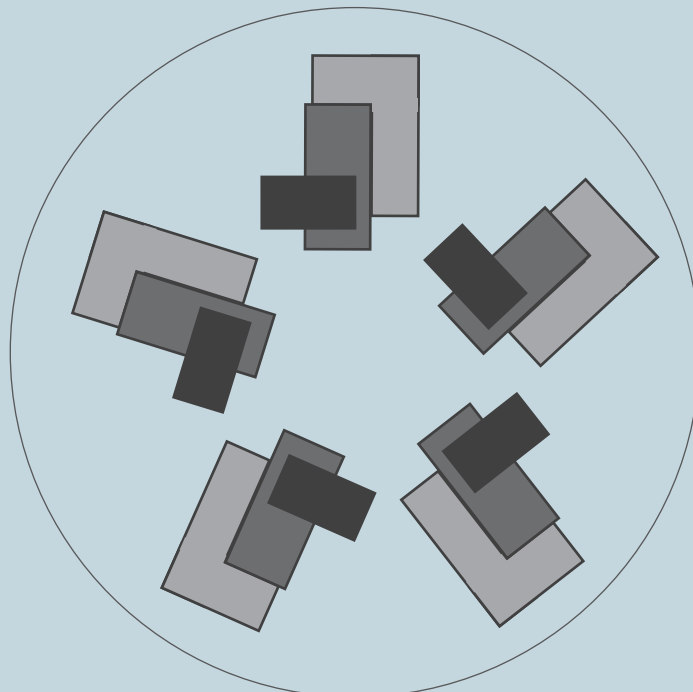

ice model configuration

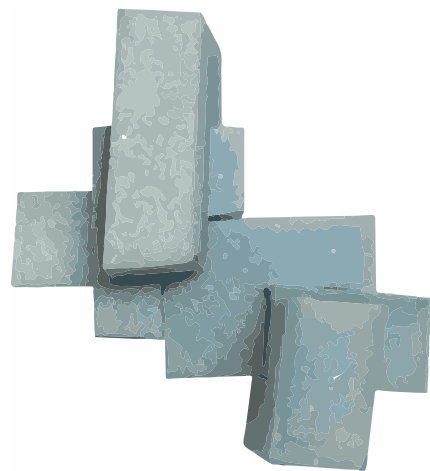
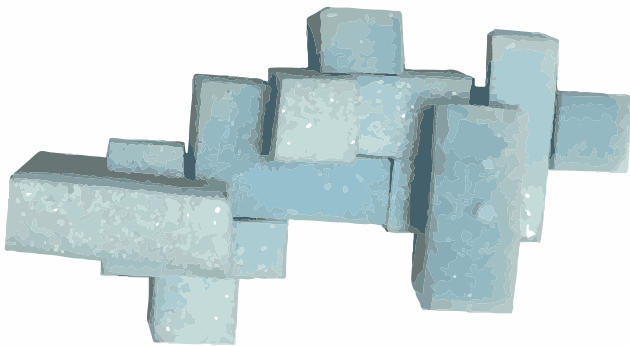
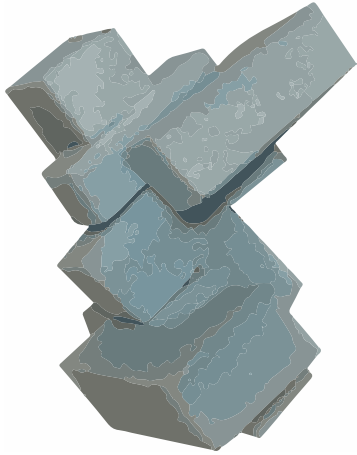

final product

